

JZ系列静态中间继电器

一、概述

JZ-系列中间继电器采用集成电路原理构成，具有良好的抗振动，适用于各种电力继电器保护和自动控制装置中，以增加保护和控制回路的触点容量和触点数量。

二、型号命名及含义

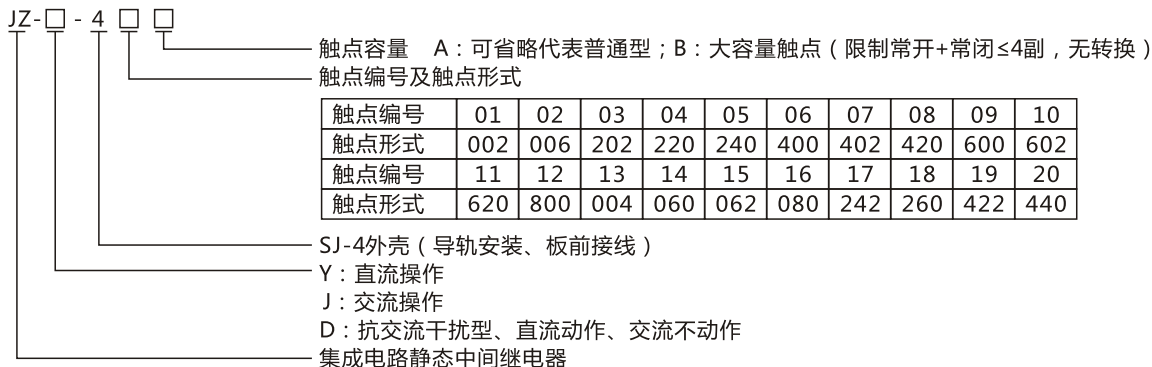
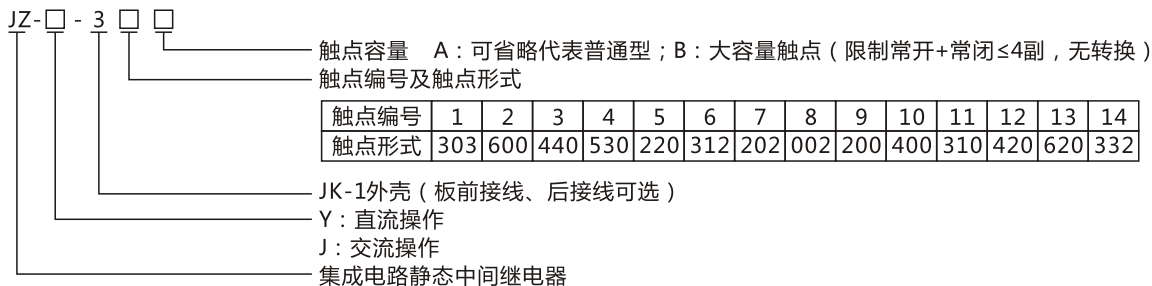
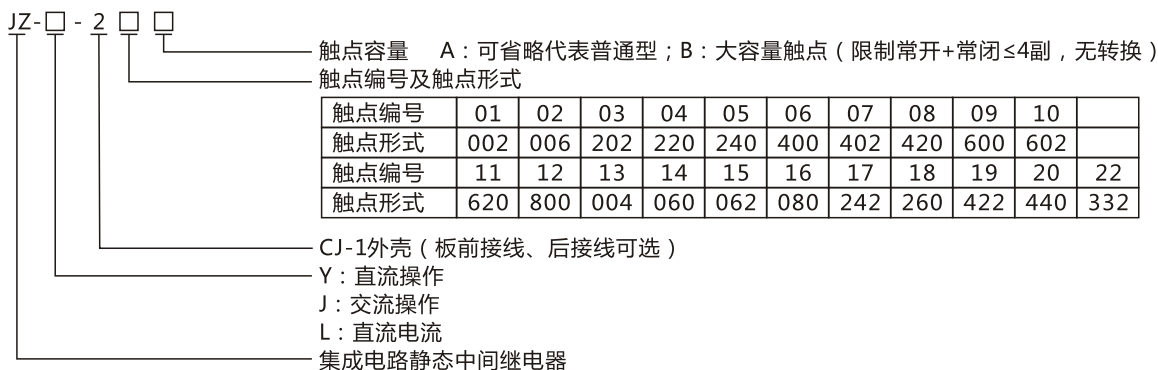
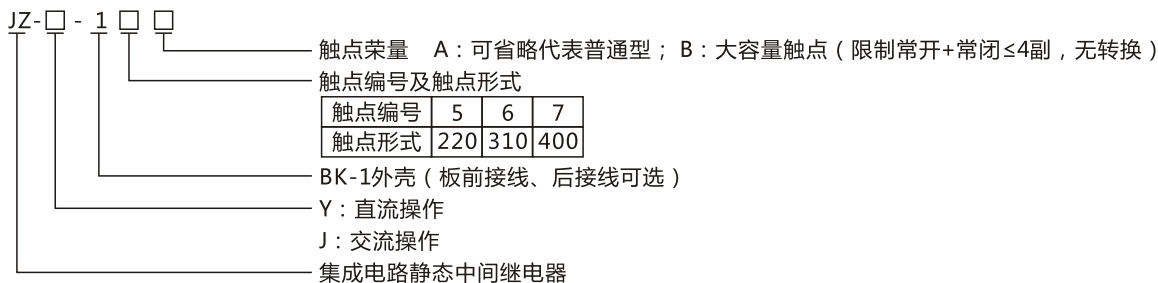

三、主要性能

常规100V和220V的电磁型中间继电器所用导线很细，匝数也多，造成容易断线，可靠性低，动作时间和返回时间本系列中间继电器采用静态电子控制回路控制多个密封进口中间同时导通或断开。具有以下性能和特点：

- 1、采用高性能密封继电器、防潮、防尘、不断线、可靠性高。
- 2、动作电压准确，返回系数高，无抖动，功耗低，多个特点同时动作或返回（可控性100%）。
- 3、继电器动作后有灯光指示、有电源指示。
- 4、继电器的电气寿命和机械寿命长。
- 5、绝缘耐压水平高。触点容量大，触点接触电阻小。
- 6、抗干扰特性好，可使用于强干扰或电源电压质量很差的场所。

四、技术条件

- | | |
|--|---|
| <p>4.1 环境基准条件
 环境温度：20°C±2°C
 相对湿度：45%~74%
 大气压力：80Kpa~106Kpa
 存储和运输过程中的极限温度：-25°C~75°C
 使用地点的海拔高度：不高于2500米
 使用环境的周围介质无爆炸危险；不含有腐蚀性气体；所含导电尘埃的浓度不应使绝缘水平降低到允许值以下。</p> <p>4.3 继电器额定值 额定电压值：48V，110V，220V，AC，DC，380VAC。</p> <p>4.4 触点容量 在电压不大于250V，功率因数COSΦ为1.0的交流电路中，可分断10A。
 直流：普通型：接通DC220V，10A；断开DC220V，τ=5mS，50W负载。
 B型：接通DC220V，10A；断开DC250V，τ=5mS，500W大容量触点，极限容量为1500W。</p> <p>4.5 保持值 0.7~1.2倍额定电压 JZ-系列快速中间继电器动作时间和返回时间不大于15mS。</p> <p>4.6 功耗 在额定电压下不大于6W。</p> <p>4.7 绝缘电阻 用1000V摇表测量各引出端子对外壳锁紧螺钉之间绝缘电阻不小于10MΩ。</p> <p>4.8 绝缘电压 各引出端子对外壳锁紧螺钉能承受工频2000V，同组触点之间能承受工频1000V，历时一份钟试验，无击穿。</p> <p>4.9 电寿命 A型：DC250V回路，切断电流τ=5mS，50W，10⁴次以上；
 B型：DC250V回路，切断电流τ=5mS，500W，10⁴次以上；1500W，10³次。</p> <p>4.10 机械寿命 触点无负荷300万次以上。</p> | <p>4.2 正常使用条件
 环境温度：-25°C~+40°C
 环境相对湿度：不大于90%
 大气压力：80Kpa~110Kpa</p> |
|--|---|

五、JZ-□-1□ 内部接线图及外引接线图（正视图）

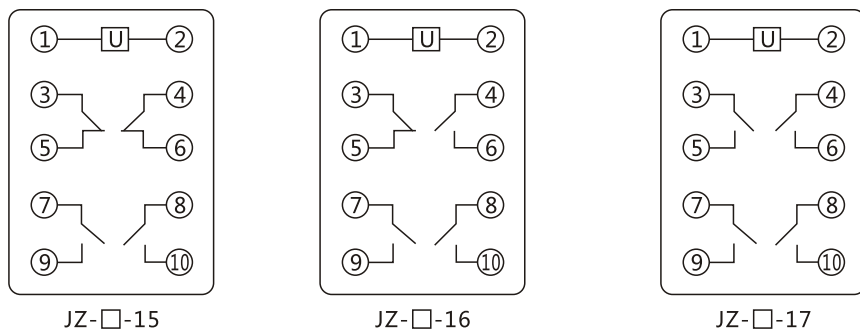

六、JZ-□-2□□ 系列内部接线图及外引接线图（正视图）

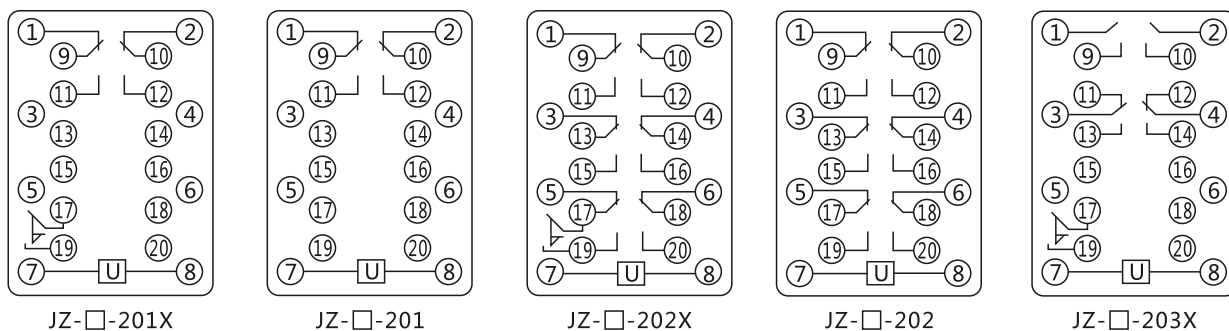

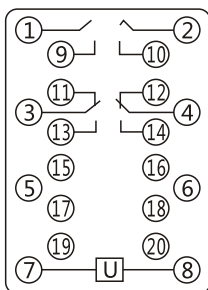

JZ-□-203

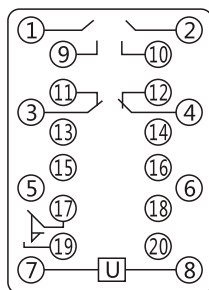

JZ-□-204X

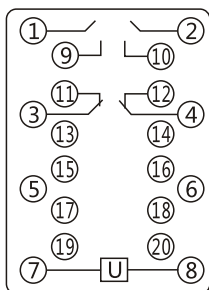

JZ-□-204

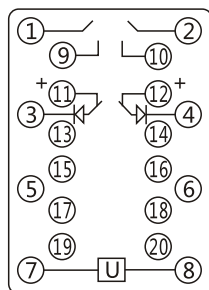

JZ-□-204A-D

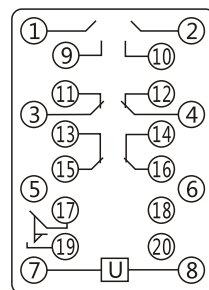

JZ-□-205X

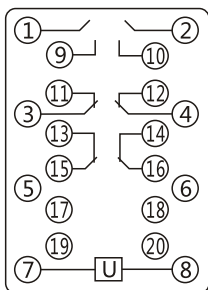

JZ-□-205

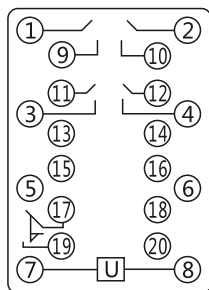

JZ-□-206X

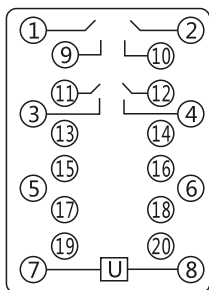

JZ-□-206

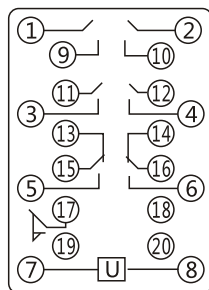

JZ-□-207X

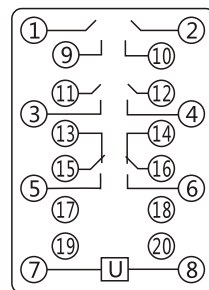

JZ-□-207

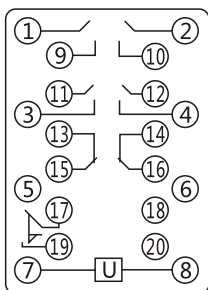

JZ-□-208X

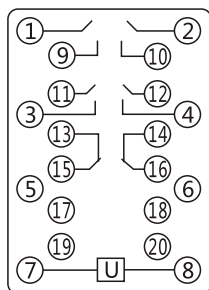

JZ-□-208

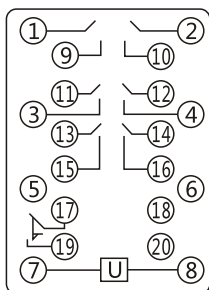

JZ-□-209X

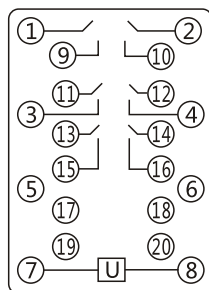

JZ-□-209

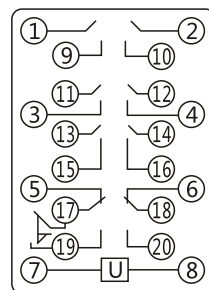

JZ-□-210X

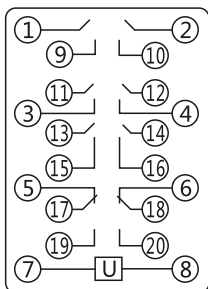

JZ-□-210

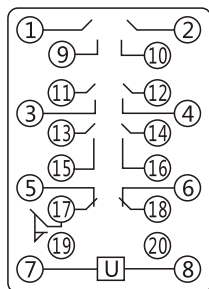

JZ-□-211X

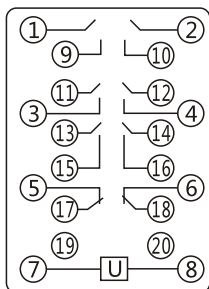

JZ-□-211

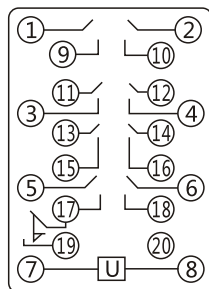

JZ-□-212X

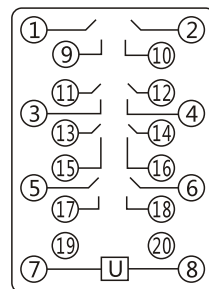

JZ-□-212

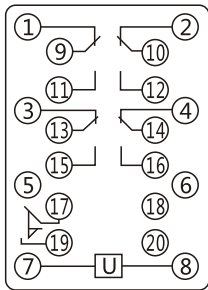

JZ-□-213X

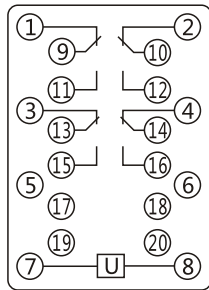

JZ-□-213

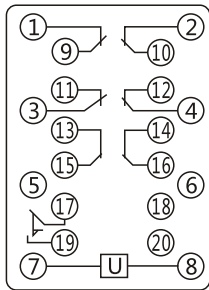

JZ-□-214X

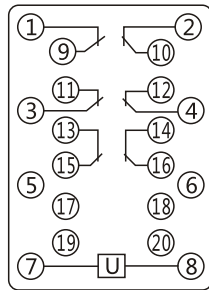

JZ-□-214

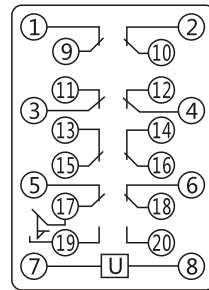

JZ-□-215X

JZ系列静态中间继电器

客服：400-086-0076 商务：021-51021899

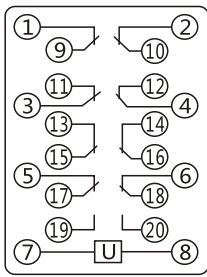

JZ-□-215

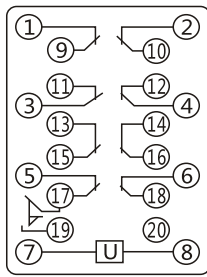

JZ-□-216X

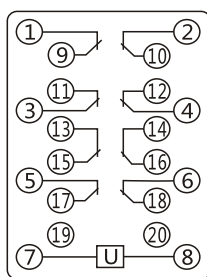

JZ-□-216

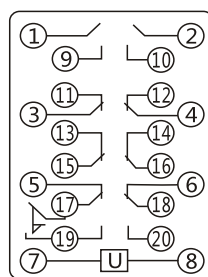

JZ-□-217X

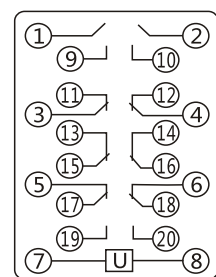

JZ-□-217

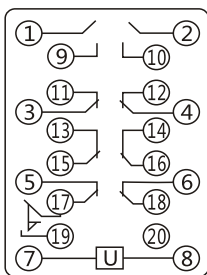

JZ-□-218

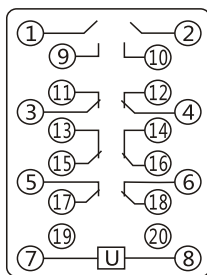

JZ-□-206X

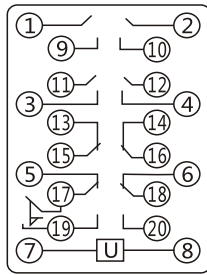

JZ-□-219X

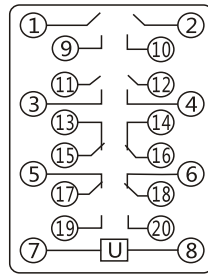

JZ-□-219

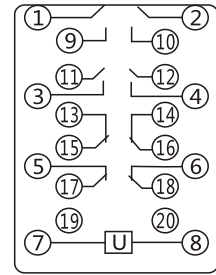

JZ-□-220

七、JZ-□-3□□ 系列内部接线图及外引接线图（正视图）

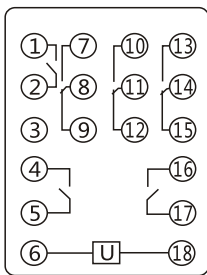

JZ-□-31

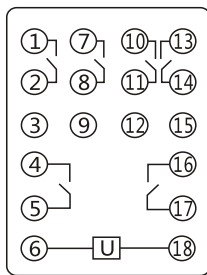

JZ-□-32

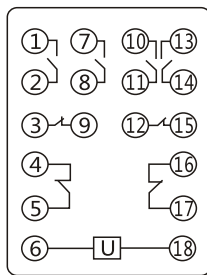

JZ-□-33

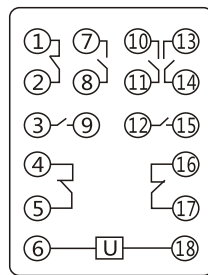

JZ-□-34

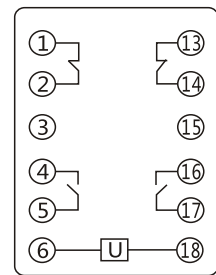

JZ-□-35

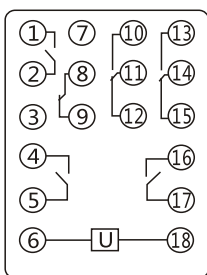

JZ-□-36

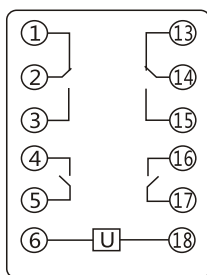

JZ-□-37

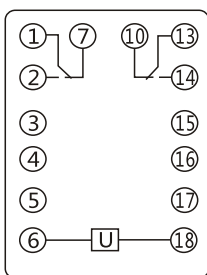

JZ-□-38

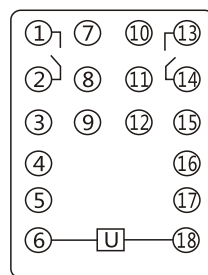

JZ-□-39

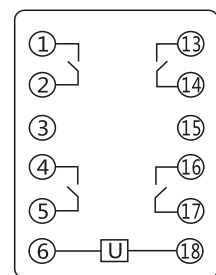

JZ-□-310

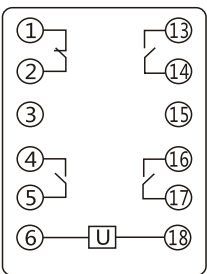

JZ-□-311

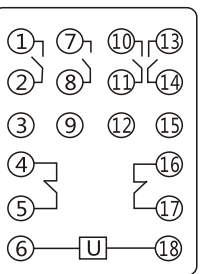

JZ-□-312

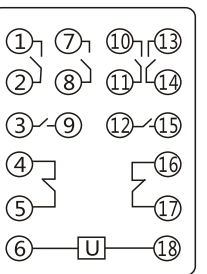

JZ-□-313

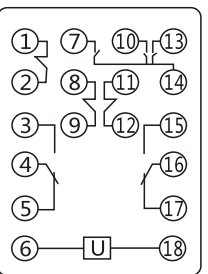

JZ-□-314

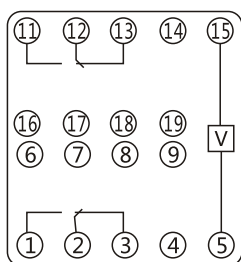

JZ-Y, JZ-J-401

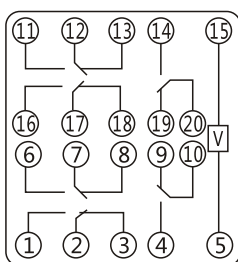

JZ-Y, JZ-J-402

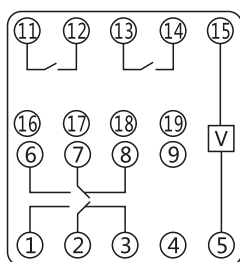

JZ-Y, JZ-J-403

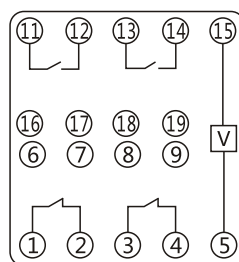

JZ-Y, JZ-J-404

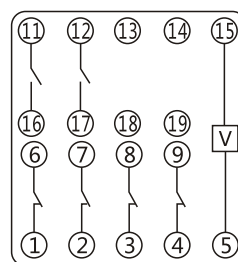

JZ-Y, JZ-J-405

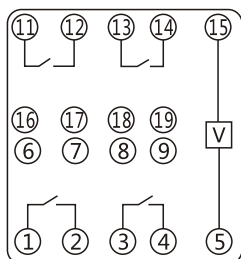

JZ-Y, JZ-J-406

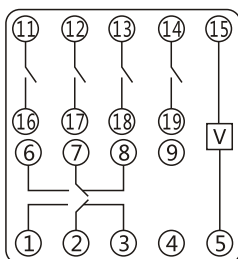

JZ-Y, JZ-J-407

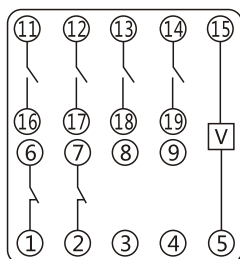

JZ-Y, JZ-J-408

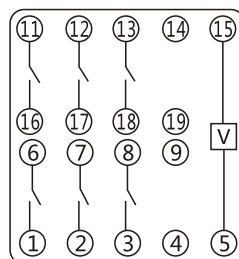

JZ-Y, JZ-J-409

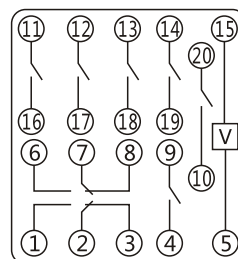

JZ-Y, JZ-J-410

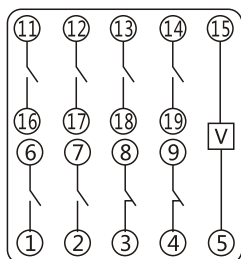

JZ-Y, JZ-J-411

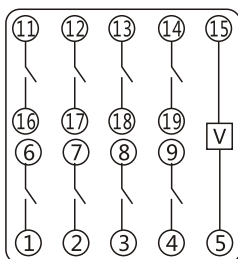

JZ-Y, JZ-J-412

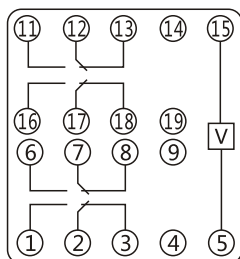

JZ-Y, JZ-J-413

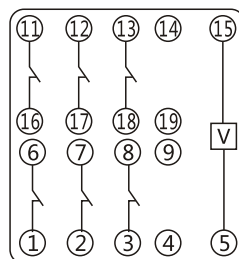

JZ-Y, JZ-J-414

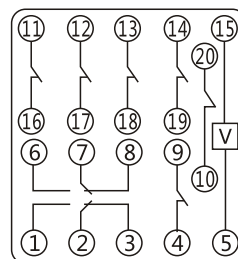

JZ-Y, JZ-J-415

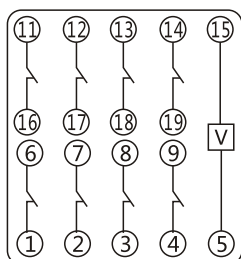

JZ-Y, JZ-J-416

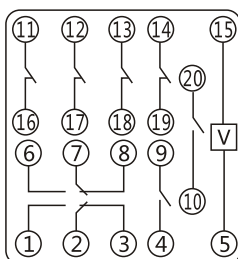

JZ-Y, JZ-J-417

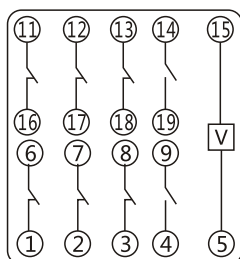

JZ-Y, JZ-J-418

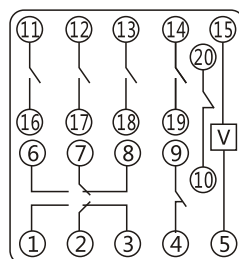

JZ-Y, JZ-J-419

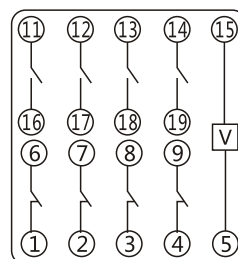

JZ-Y, JZ-J-420

九、JZ-□ 系列继电器外形尺寸及开孔尺寸

JZ-□-1采用BK-1壳体，见337页附图5。

JZ-□-2采用JK-1壳体，见335页附图2。

JZ-□-3采用CJ-1壳体，见336页附图3。

JZ-□-4采用SJ-4壳体，见336页附图4。

单位：mm

图号	结构	外形尺寸图	安装开孔尺寸图	端子图
附图 5	BK-1 凸出式前接线			<p>(正视)</p>
附图 5	BK-1 凸出式后接线			<p>(正视)</p>
附图 2	JK-1 板后接线			<p>18点端子 8点端子</p> <p>背视</p>
附图 2	JK-1Q 板前接线			<p>正 视</p>

单位：mm

图号	结构	外形尺寸图	安装开孔尺寸图	端子图
附图 3	CJ-1 嵌入式后接线 A11K			
附图 3	CJ-1 板前接线 A11Q			
附图 3	CJ-1 凸出式板后接线 A11H			
附图 4	SJ-4 凸出式前接线 卡轨安装 或 螺钉安装			